

Article number: 20818510
Description: E+G Collar nut
DIN 6331-M8

Measures

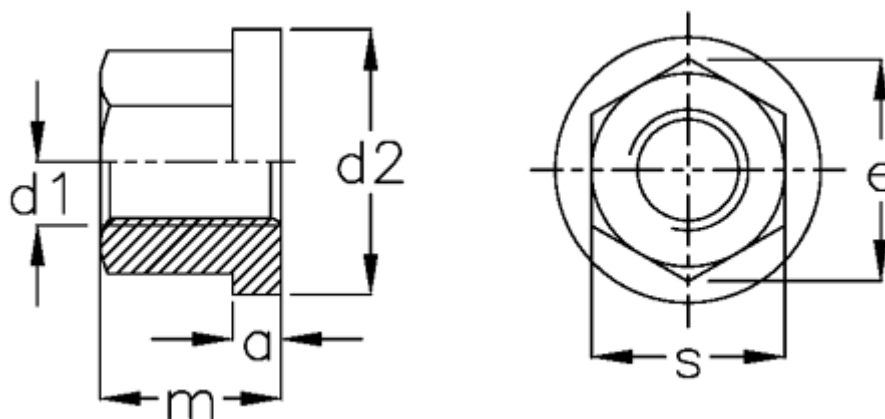

a = 3.5
d1 = M8
d2 = 18
e = 15.0
m = 12
s = 13